

КАТАЛОГ ПРОДУКЦИИ

НАВЕСЫ НАД ТРК

2015

Этапы монтажа навесной группы

Монтаж навесной группы модификации “Стандарт 2” производится за 7 рабочих дней





Расшифровка обозначений модификаций АЗС

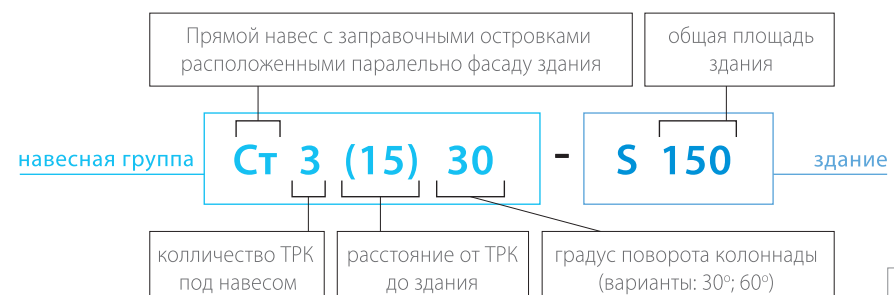
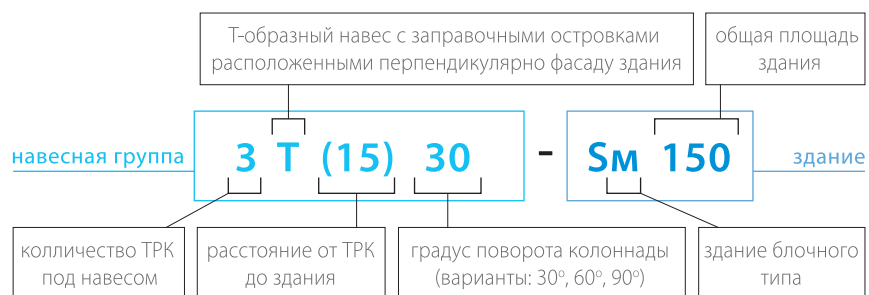

Навесы над ТРК серии "Л"

Л1

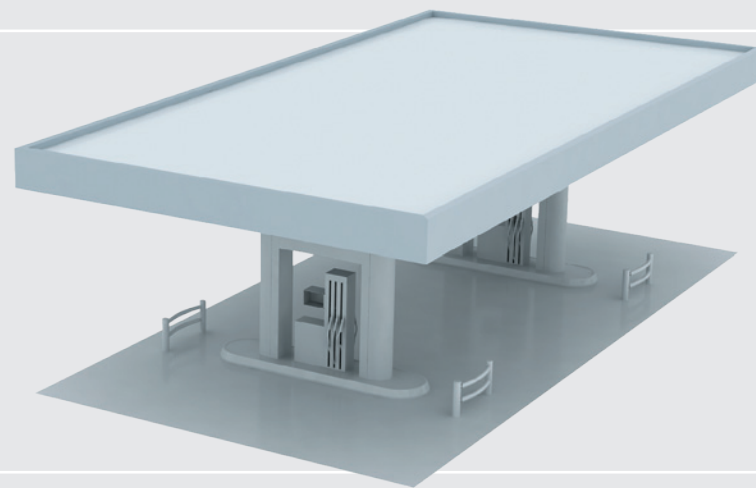
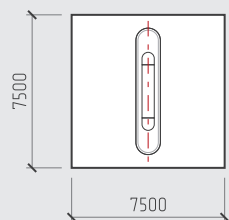

Л2

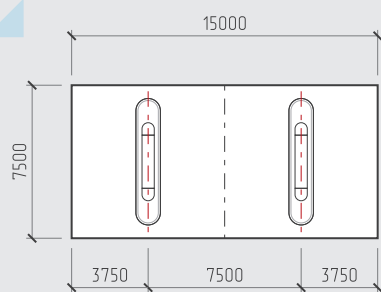

Л2 30

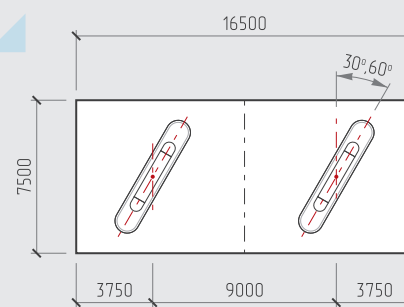

Л3

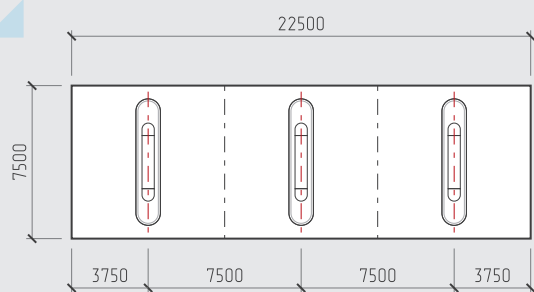

Л3 30

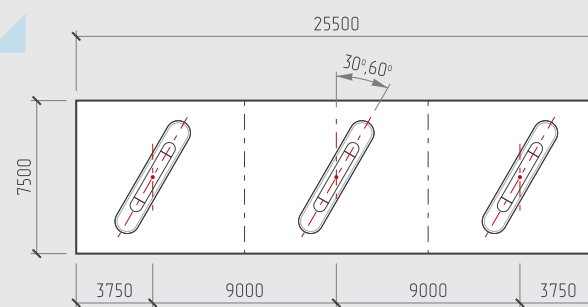

Л4

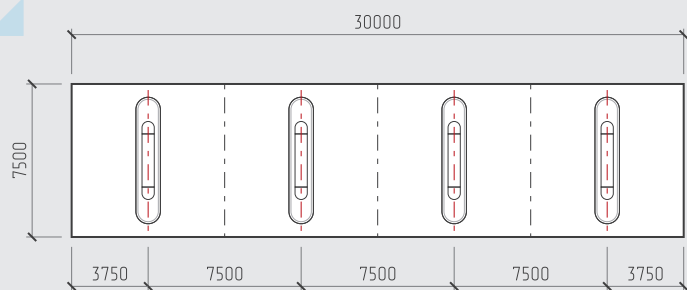

Л4 30

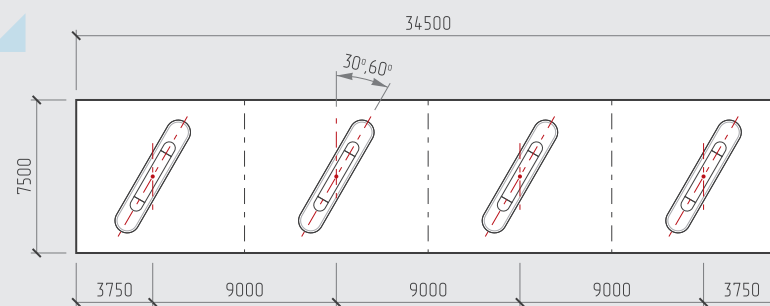



Навес над ТРК "Л1"



Навес над ТРК "Л2"

Навес над ТРК “Л3”



Навес над ТРК “Л4”



Ст 1(9)

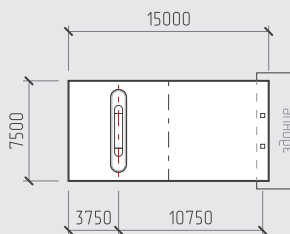

Ст 2(9)

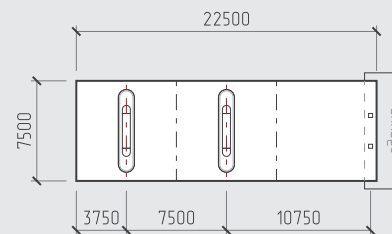

Ст 2(9)30

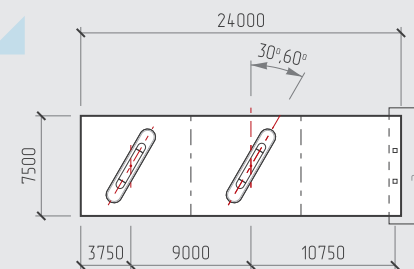

Ст 3(9)

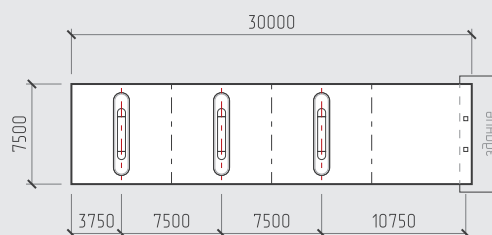

Ст 3(9)30

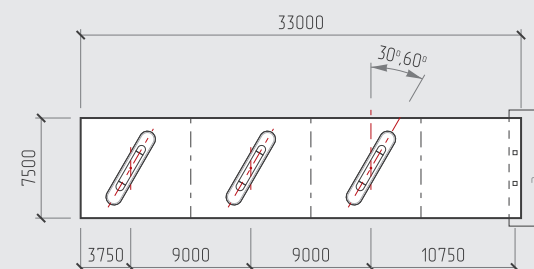

Ст 2(15)

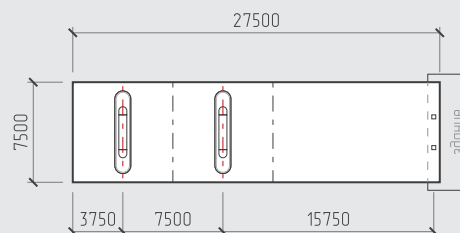

Ст 2(15)30

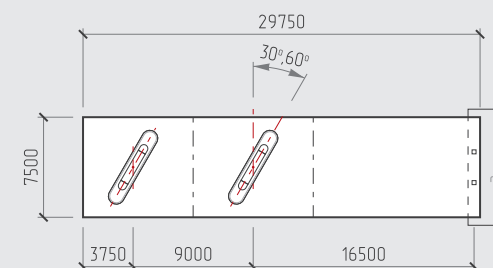

Ст 3(15)

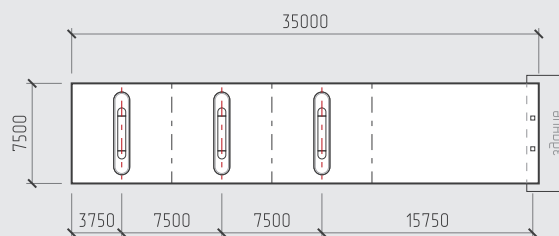

Ст 3(15)30

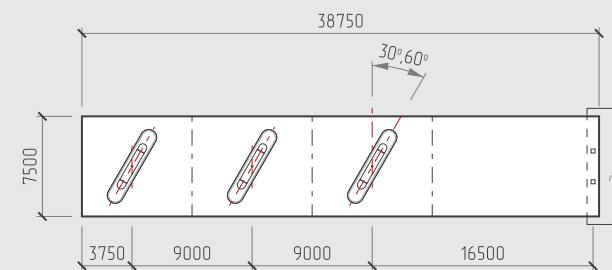

Ст 4(15)

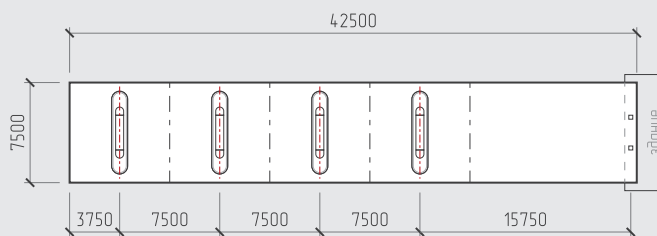

Ст 4(15)30

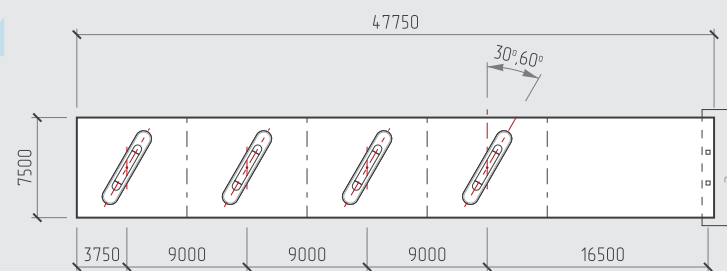

Навес над ТРК “Ст 1(9)”



Навес над ТРК “Ст 1V(9)”



Навес над ТРК “Ст 2(15)30”



Навес над ТРК “Ст 3(15)”



2Т(15)

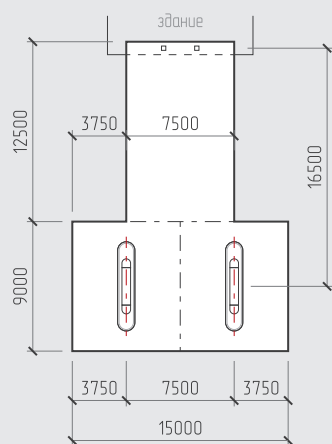

2Т(15) 30

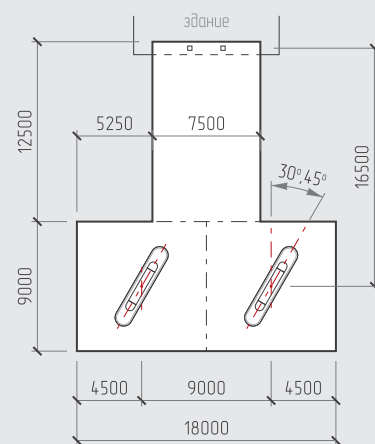

3Т(15)

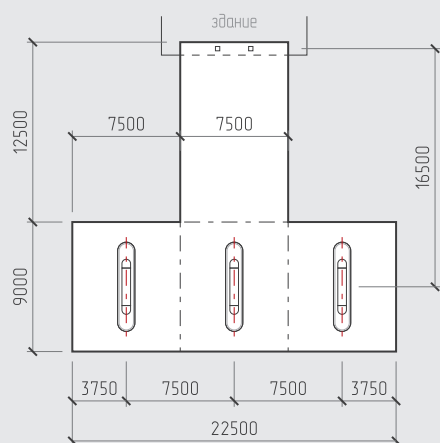

3Т(15) 30

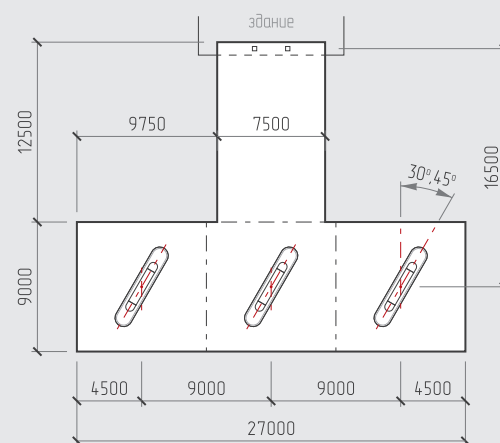

4Т(15)

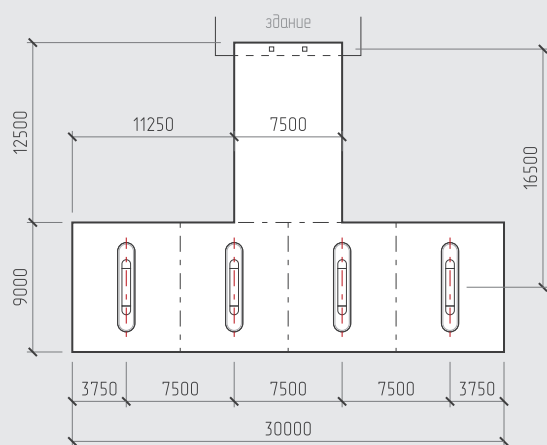

4Т(15) 30

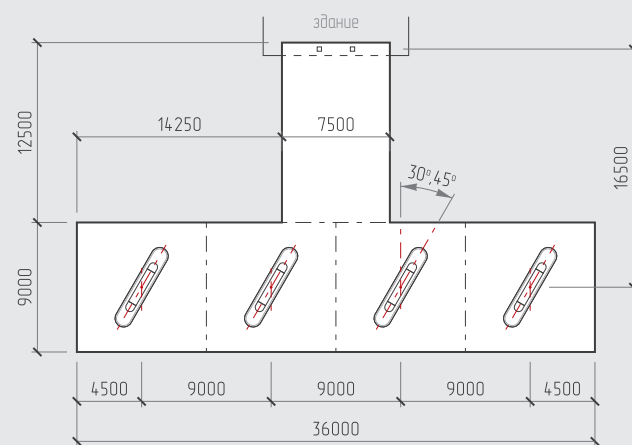

Навес над ТРК “2Т(15) 60”



Навес над ТРК “2Т(15) 90” моноколонна



Навес над ТРК “ЗТ(15)”



Навес над ТРК “ЗТ(15)” моноколонна



Навес над ТРК “3Т(15)”



Навес над ТРК “4Т(15)”



тип 1



тип 2



тип 3

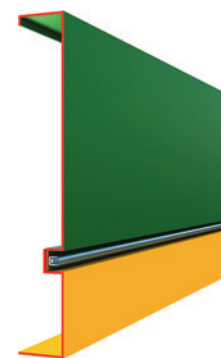

тип 4

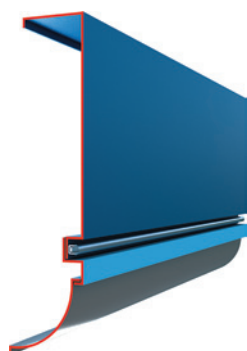

тип 5

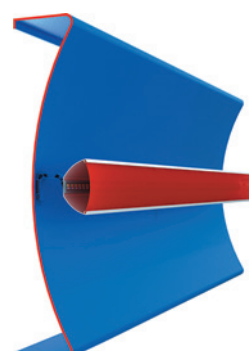

тип 6

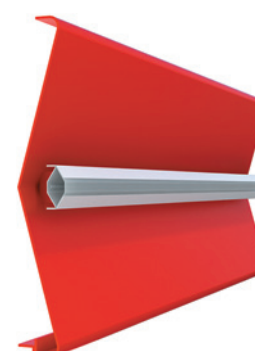

тип 7



тип 8

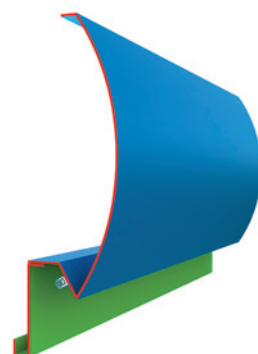

тип 9

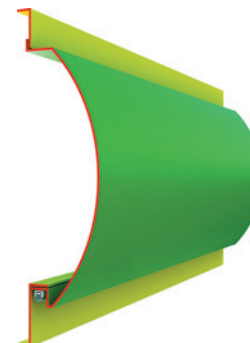

тип 10



тип 11



тип 12



Рекламное оформление навесных групп. Варианты колоннады.

колоннады тип "КП"



колоннада тип "KV"



колоннады тип "КП"



варианты моноколонн



Рекламное оформление навесных групп. Отдельные заправочные островки.

варианты ОЗО тип "КП"



варианты ОЗО тип "моноколонна"

